



ARCHITECTURAL  
GRATES + DRAINS



# SD90H

## Slot Drain



### 90mm Drain with UPVC Beige Insert

The SD90 features a 25mm opening on the top with 20 slots draining into a concealed 90mm drain pipe with UPVC beige insert.

The PVC insert comes with 10mm holes at 50mm centres .

The Slot Drain can be completed with a 30mm wide architectural wedge-wire grate as an optional item.

**Code** SD90H

**Range** Slot Drain

**Category** Modular Kits

**Channel Material** uPVC

### SPECIFICATIONS + DIMENSIONS

<b>Channel Width</b>	25mm
<b>Channel Depth</b>	Adjustable
<b>Length(s)</b>	3030mm
<b>Outlet Size</b>	N/A

### PRODUCT APPLICATIONS

- Commercial Drainage
- Courtyard / Patio Drainage
- Driveway Drainage
- Pool and Spa Area Drainage
- Paved Area Drainage

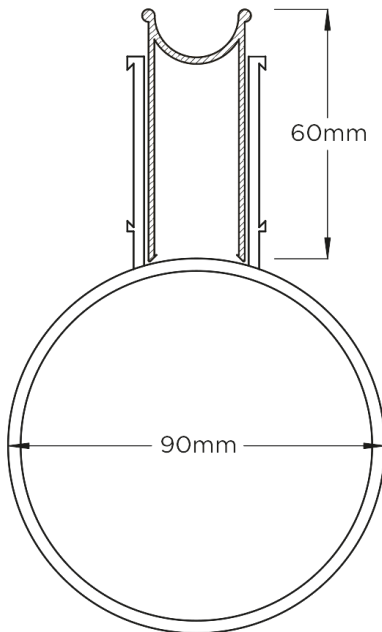

Copyright © Stormtech Pty Ltd. Patent 733361. Drawings not to scale, please use dimensions shown.  
Downloaded 06/06/2026 (please check for updates)

Grates longer than 1500mm supplied in sections. Tile Inserts longer than 1200mm supplied in sections. Channels over 3000mm supplied in sections with joiner. +/-2mm tolerance on dimensions.



Visit [stormtech.com.au](http://stormtech.com.au)  
for tools + inspiration.

Phone **1300 653 403**

Email [info@stormtech.com.au](mailto:info@stormtech.com.au)